



Scan for Current
Matko Manuals

SSD Series Manual

Contents



Section 1	Physical Dimensions	3-4
Section 2	Wiring Configuration	5-7
Section 3	Quick Set up Procedure	8
Section 4	Option Summary	9
Section 5	Option Details	10-16
Section 6	Stoptlight Instructions	17-19
Section 7	Wireless Instructions	20-23
Section 8	Troubleshooting	24
Section 9	ASCII Table	25
Section 10	Replacement Parts	26
Section 11	Manual Revision History	27

Section 1: Physical Dimensions

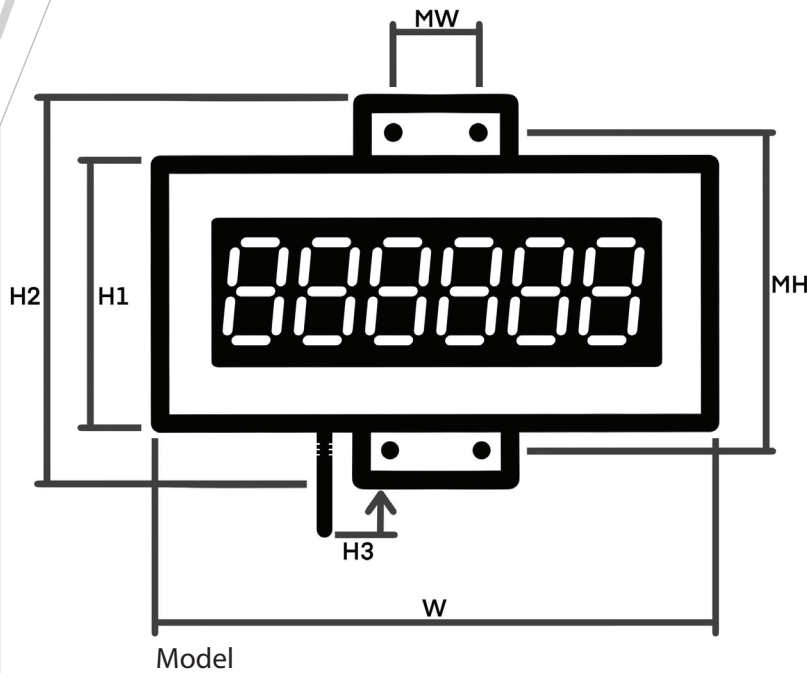

Figure 1.1: Front Profile

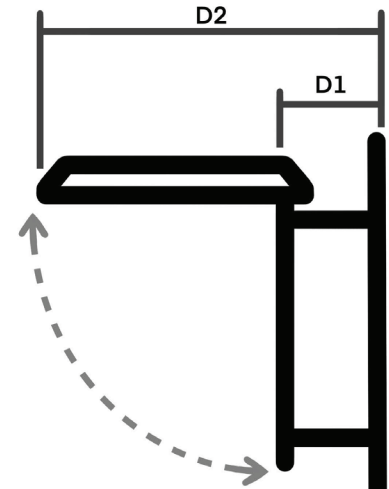

Figure 1.2: Side Profile

Model	W	H1	H2	H3	MW	MH	D1	D2
SSD-2	15	8	10	5	4	9	3.5	10
SSD-2-TRISG	19	8	10	5	4	9	3.5	10
SSD-5	33	14	15	5	4	12	3.5	16
SSD-5-TRISG	38	14	15	5	4	12	3.5	16
SSD-8	45	16	17	5	4	14.75	3.5	18
SSD-8-TRISG	53	16	17	5	4	14.75	3.5	18

Chart 1.1: Display Sizes (Inches)

Section 1: Physical Dimensions

Cont.



Model	Minimum	Optimum	Maximum
SSD-2	3	5-35	75
SSD-2-TRISG	3	5-35	75
SSD-5	12	25-125	175
SSD-5-TRISG	12	25-125	175
SSD-8	20	65-250	250
SSD-8-TRISG	20	65-250	250

Chart 1.2: Viewing Distances (Feet)

Section 2: Wiring Configuration



Connect the Scale indicator using the appropriate diagram to the **BLACK** terminal block on the Input Card (See Figure 2.2).

	Indicator	Pin	Display
Indicators with Active 20 mA Output	+20mA	5	RX CL (+)
	-20mA	4	RX CL (-)
Indicators with Passive 20 mA Output	+20mA	1	VCC
		2	GROUND
	-20mA	4	RX CL(-)
		5	RX CL(+)
Indicators with RS232 Output	TXD	3	232 RXD
	GND	2	GROUND
Indicators with RS422 Output	TX 422A (+)	6	RX 422A
	TX 422B (-)	7	RX 422B

Figure 2.1: Wiring Diagram

The corresponding green LED will blink with every data transmission.

Data Transmission (GREEN Terminal Block)

There is a hardware echo for Current Loop on GREEN Terminal Block pins 1 and 2 as well as a hardware RS 232 echo on pins 3 and 4. Any character received through the BLACK terminal block automatically is sent out these 2 ports, allowing for a boosted signal. There are also two software ports for data transmission. RS232 on Pins 4 and 5 and RS422 on pins 6 and 7 of the GREEN terminal block. See Option 18 for details

***DATA RELIABILITY in the following order:**
RS422/485 (Up to 4000 feet)
Current Loop (Up to 2000 feet)
RS232 (Up to 50 feet)

Section 2: Wiring Configuration

Cont.

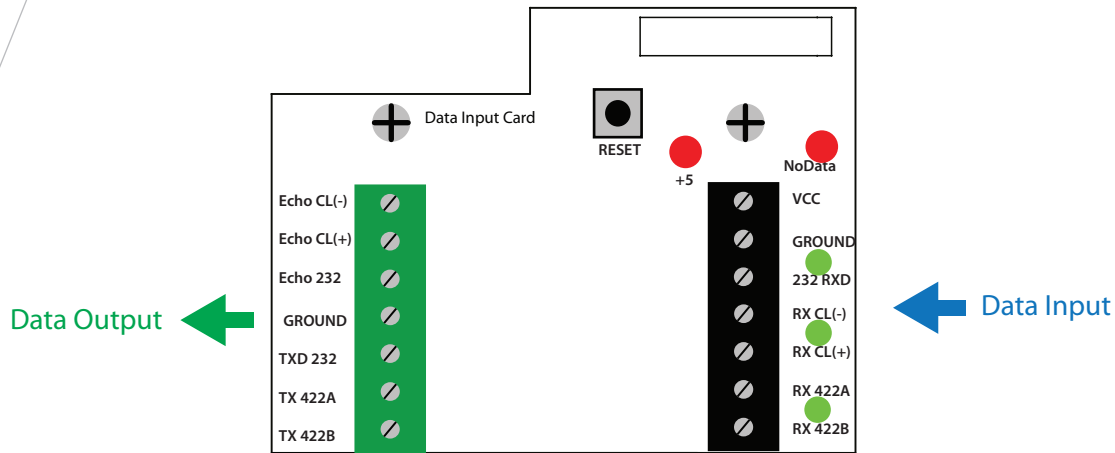
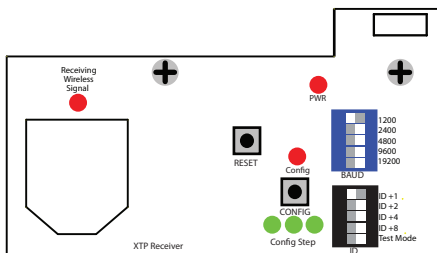
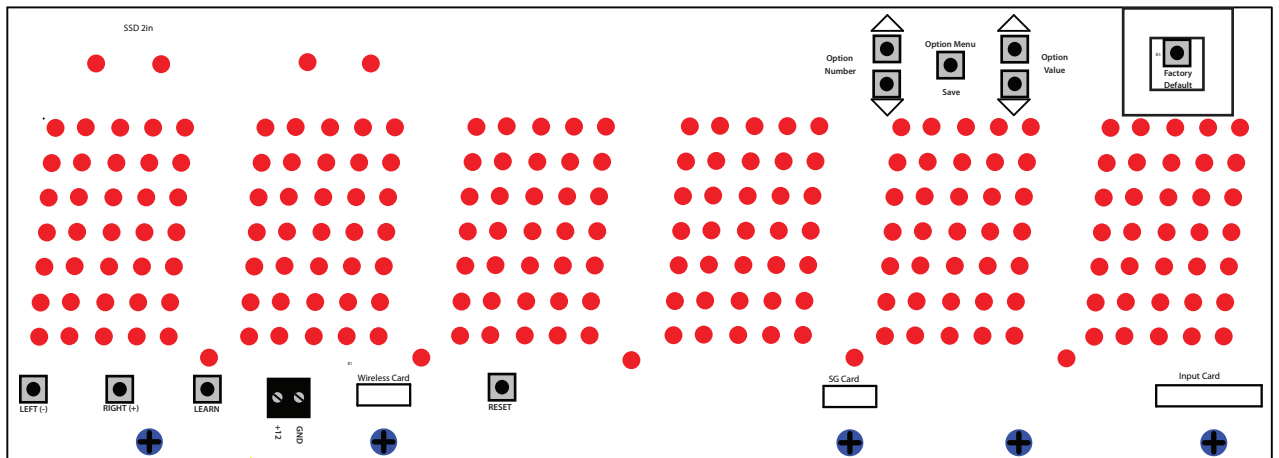
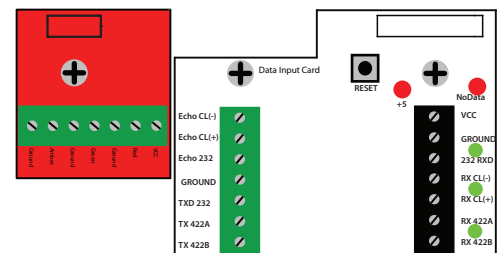

Figure 2.2: Input Card-SSD

Figure 2.3: L2-SSD with installed cards



Optional
XTP-BIR



Optional
SG-Card-SSD

Input-Card-SSD

Section 2: Wiring Configuration

Cont.



Figure 2.4: L5-SSD-L with installed Cards

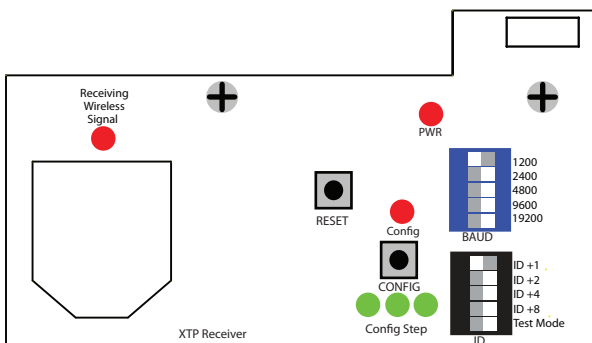
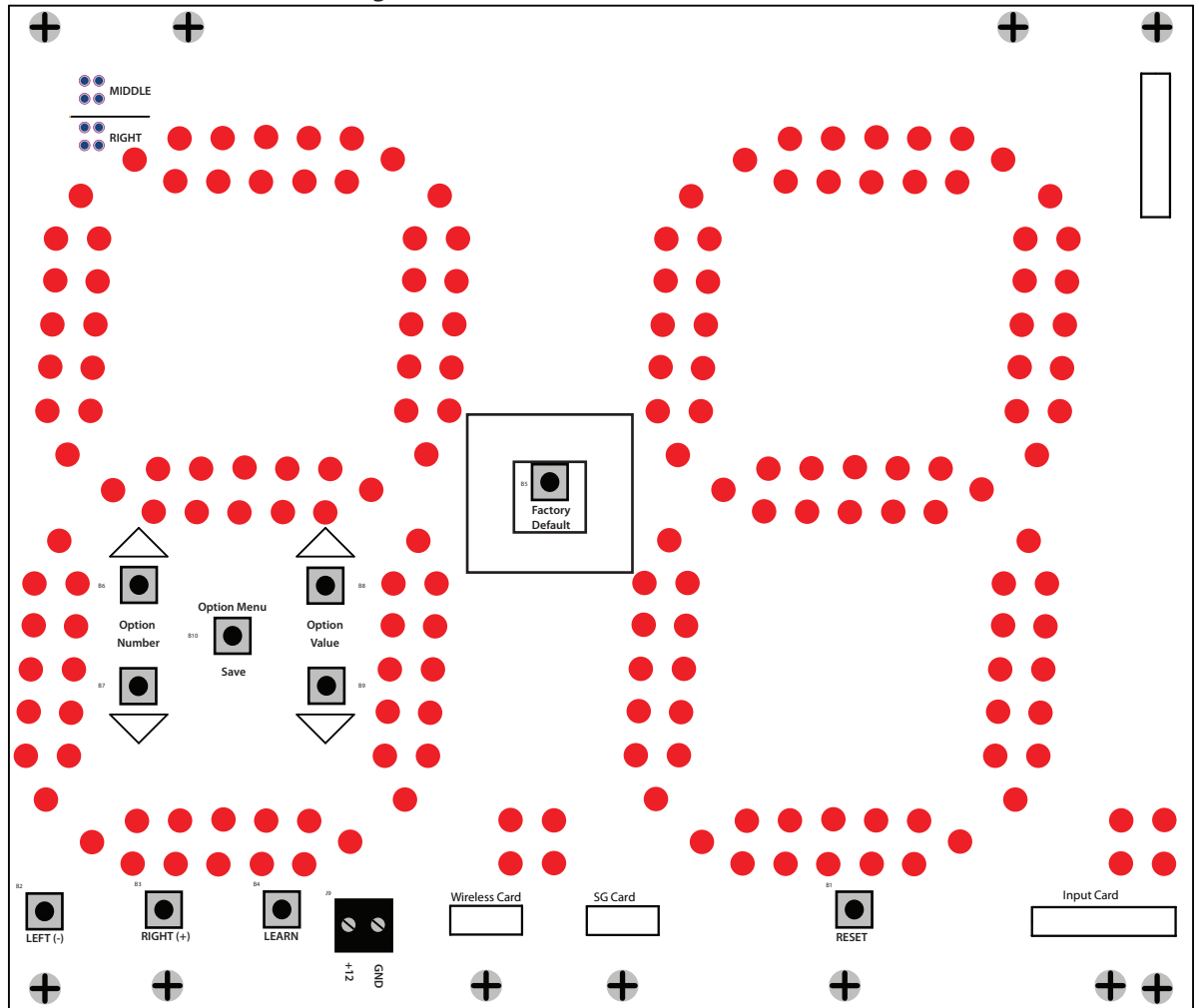

**Optional
XTP-BIR**

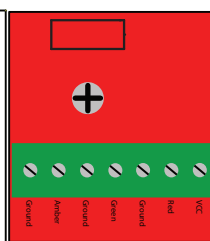

**Optional
SG-Card-SSD**

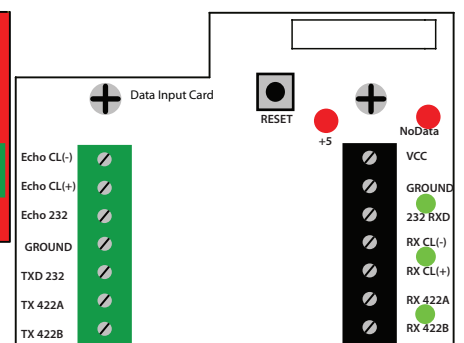

Input-Card-SSD

Section 3: Quick Setup Procedures



If possible place a weight on the scale. Wire up the display according to Section 2 and configure the transmitting device to output continuously. The Corresponding LED will blink when properly wired and the indicator is transmitting. Hold the **FACTORY DEFAULT** button until the display counts down. At the end of countdown the display will flash "LEARN" then the BAUD rate such as 1200 and then the weight. Shift the data using the **LEFT** and **RIGHT** buttons until the desired weight is in view.

To change the display's intensity:

Press and release the **RESET** button

Hold the **RIGHT** button during countdown

At the end of countdown the **RIGHT** button will toggle between displaying "high" and "low"
(On 7 segment displays "lo" is displayed)

Select the desired intensity and press **LEARN** to save changes

Factory default is "low"

***Intensity may also be adjusted using Option 6 (See Sections 4/5)**

SSD Series Specs

Protocol	Interface
8 Data bits No Parity 7 Data bits Odd Parity 7 Data bits Even Parity 300 to 19200 Baud	RS 232 RS 422/485 20mA Current Loop Active/Passive Optional Interface 4-20 mA or Wireless

Power

All SSD Displays can run on 12 VDC by bypassing the power supply and connecting 12 VDC directly to the LED board. Do not run more than 12 VDC without ordering a DC power supply as over voltage can damage the unit.

Standard Units:
~110-240

DC Units:
~12-35 VDC

Section 4: Option Summary



During normal operation, pressing the **Option Menu/Save** button will enter into the option settings. **Option Number UP/DOWN** will toggle through the available options numbers and **Option Value UP/DOWN** will adjust the values of the selected option. At any time pressing the **Option Menu/Save** button will resume normal operation

To restore to factory default, press the **Factory Default** button. The display should briefly display "Default" then count down. Option training videos may be found at www.matko.com/SSDVideos

#	Name	Description for "ON" Value
0	Default	Resets all settings to factory defaults
1	Addressable	Makes the display addressable
2	Toledo / Fairbanks	Decodes Toledo / Fairbanks status bytes
3	Time out Length	Maximum time allowed between data transmissions Default = 5 seconds
4	On Demand	Data received less than once a second
5	No Data	Set what is displayed when no data is received
6	Intensity	Set the intensity low 0 or high 1
7	Red Stoplight	See Section 6
8	Green Stoplight	See Section 6
9	Amber Stoplight	See Section 6
10	Minimum Weight	Sets the minimum weight to display
11	Maximum Weight	Sets the maximum weight to display
12	Fairbanks Addressable	Addressable for Fairbanks 40-41
13	Shift	Set the shift amount
14	Baud	Sets the baud rate
15	End Character	Sets the end character
16	Hardware Test	Test Hardware Serial Ports
17	Stream View	View the decimal value of the serial stream
18	Software Echo	Transmit data out RS232 and RS422 ports
19	Disable Alpha	Will display only numeric characters
20	No Count Down	Does not count down on startup
21	No 0 Suppression	Does not suppress leading 0's
22	No Shift	Disable auto shifting while learning
23	Mirror	Displays data to be seen in a rear view mirror
24	Fixed Decimal	Sets a fixed decimal point position
25	Fixed Annunciators	Fix the LB/KG and GR/NT annunciators indicated regardless of data stream
26	Demo Mode	Cycle through different weights as a demo
27	Counter	Count Up/Down based on signal input (requires SG-SSD Card)
28	Siemens	Use Siemens BW500 Modbus Protocol (manual at www.matko.com/siemens/)
29	Blank Out Character 1	Sets a character to cause the scoreboard to blank
30	Blank Out Character 2	Sets a character to cause the scoreboard to blank
31	Blank Out Character 3	Sets a character to cause the scoreboard to blank
32	Grams/Ounces	Display annunciators for grams and ounces (Requires Custom Decals)
33		
34	Version	Displays the current software version

Section 5: Option Details



0: Restore Factory Defaults

Option 0 resets the display to factory default. It erases all data stored in memory including shift amount, baud rate, end character, and sets all options to off.

1: Addressable

Option 1 will set the display to be addressable. The display will ignore any characters until the addressable character is received, then display the data immediately following it. The addressable character can be set to any character from 1 to 255. The number selected represents the decimal equivalent of the desired character. For example if an "A" is at the beginning of the data stream then you would set the address to 65. See Section 9 for ASCII character values. If the indicator is sending 7 data bits even or odd parity then the parity bit may change the decimal value of the character by adding 128 to it. We recommend setting the indicator to 8 data bits no parity for convenience. Default (off) uses standard data stream.

2: Toledo

When Option 2 is set to 1 the unit will decode standard Toledo Style Data Stream. When Option 2 is set to 2 the unit will decode extended Toledo Format Stream. By Default the displays will show 'lb' and 'kg' as units of measurement. The Toledo streams can encode other units of measurement. In these circumstances custom decals may be used. "lb" may be replaced with 'oz', 'to', or 'pw' for ounces, troy ounces, or penny weight. 'kg' may be replaced with "T", 't', or 'gr' for tons, metric tons, or grams.

3: Timeout Length

Option 3 is used to set the time out length. The time out length is the maximum amount of time expected between data streams before communication is considered interrupted. The default (0) acts as a 5 second time out, all other values represent the number of seconds the display will wait for a new data stream. The display will then do one of three things after the time out depending on how Option 5 is set. The maximum time out allowed to be set is 255 seconds.

4: Display on Demand

Option 4 sets the display for On Demand mode. It is recommended to be turned on when connected to the print button of an indicator or when data is only sent once every 2 or more seconds. While in On Demand mode the display will wait for and display every data stream. While in the default (0) the display uses every other data stream to ensure data integrity.

Option Details Cont.



5: No Data

Option 5 sets the display to do one of three things after a data stream time out. The default is to display "NoData". The other two options are "Clear" (blank the display) and "Hold" (keep the last weight sent). The time out length can be specified with Option 3. **Option Menu/Save** selects the displayed option and returns the standard Option Menu showing the option number and option Value. 0 is "NoData", 1 is "Clear", and 2 is "Hold".

6: Intensity

Option 6 is used to set the LED intensity to low (0) or High (1). See Section 3 for an alternative way to set the intensity.

7: Red Stoplight

8: Green Stoplight

9: Amber Stoplight



See Section 6

10: Minimum Weight & 11: Maximum Weight

Options 10 and 11 sets the minimum and maximum weights the display will show. Any weights outside the range will cause the display to blank. Pressing **Option Value Up/Down** will enter into the Min Max Sub Menu consisting of 6 weight digits with the left most flashing. **Option Value Up/Down** will adjust the value of the flashing digit. The selected digit can be changed with either the **LEFT** and **RIGHT** buttons or the **Option Number Up/Down** buttons. When the desired weight is selected **Option Menu/Save** goes back to the normal Option Menu. All 6 digits set to 0 is off and any other value will be shown as (1).

Minimum and Maximum weights may also be used in conjunction with the Red, Green, and Amber stoplight options. See Section 6 for more details.

Option Details Cont.



12: Fairbanks Addressable

Set option 12 only if the Fairbanks indicator is sending out multiple streams, ie. gross and tare weights or multiple scales. Set the option according to the chart.

Value	Addressable for	Value	Addressable for
1 Scale 1	40 with 7 data bits odd parity	11 Scale 3	42 with 8 data bits no parity
2 Scale 2	41 with 7 data bits odd parity	12 Scale 4/Total	43 with 8 data bits no parity
3 Scale 3	42 with 7 data bits odd parity	13 Scale 2	46 with 7 data bits odd parity
4 Scale 4/Total	43 with 7 data bits odd parity	14 Scale 3	52 with 7 data bits odd parity
5 Scale 1	40 with 7 data bits even parity	15 Scale 4	58 with 7 data bits odd parity
6 Scale 2	41 with 7 data bits even parity	16 Scale 5	64 with 7 data bits odd parity
7 Scale 3	42 with 7 data bits even parity	17 Scale 6	70 with 7 data bits odd parity
8 Scale 4/Total	43 with 7 data bits even parity	18 Scale 7	76 with 7 data bits odd parity
9 Scale 1	40 with 8 data bits no parity	19 Scale 8	82 with 7 data bits odd parity
10 Scale 2	41 with 8 data bits no parity	20 Sum of all Scales	99 with 7 data bits odd parity

13: Shift Value

Option 13 is used to set or view the shift amount. Has the same effect as shifting **LEFT** and **RIGHT** during normal operation.

14: Baud Rate

Option 14 is used to set or view the Baud Rate. **Option Value Up/Down** will cycle through the choices. **Option Menu/Save** will go back to the normal Option Menu.

0 indicates the unit has not been set, 1 = 300, 2=600, 3=1200, 4=2400, 5=4800, 6=9600 and 7=19200.

15: End Character

Option 15 is used to set or view the end character. When in learn mode the unit will look for an end of text(ETX), line feed(LF) and a carriage return(CR), which have decimal values of 3, 10, and 13 respectively. Any character may be manually selected through this option by setting it to the desired decimal equivalent of the desired character. See Section 9 for ASCII character values. If the indicator is sending 7 data bits even or odd parity then the parity may change the decimal value of the character by adding 128 to it. We recommend setting the indicator to 8 data bits no parity for convenience.

Option Details Cont.



16: Hardware Test

Option 16 will set the unit into a hardware test mode. This mode is used to test the serial ports. Remove all data connections from the indicator or PC and jumper one the desired data input according to the chart below. If the ports are working the display will toggle between "GOOD 0" and "GOOD 1". If the Display shows "ERR 1" or "ERR 0" then the port is not capable of receiving data. Try a different port or replace the Input-Card-SSD.

RS232:

Jumper 232 RXD to 232 TXD

Current Loop:

Jumper RX CL(-) to 232 TXD

Jumper RX CL(+) to GROUND

RS422--Needs to be tested in phases:

Jumper RX 422A to TX422A

Jumper RX 422B to TX422B

17: Stream View

Option 17 will capture up to 60 characters at the set baud rate and using the Option Value +/- buttons, scroll through their decimal values. The Display will show the stream position in the left 2 digits and the decimal point with decimal value on the right 3 digits. ##.###

18: Software Transmit

Data is transmitted through the GREEN Terminal Block. By default only the Hardware Echo transmits data: Echo 232 and Echo Cl (+) / (-)

This echo is done completely through hardware and no data modification is possible. Option 18 allows data to be transmitted using the TXD 232 port and the TX 422A / TX 422B ports

0-No Software transmission.

1-Data stream transmitted, No addressable character or extra end characters sent.

2-Transmit <STX> Displayed Weight <CR><LF> may be missing decimal point.

19: Disable Alpha Characters

Option 19 will disable the unit from displaying any non numeric characters. A 7 segment display is limited by the alpha characters it can display. For example it can not display characters such as "x", "q", "k", "!" or "?".

20: No Count Down

When set to 1, Option 20 will disable the display from counting down and displaying the firmware revision when powering up. When set to 2, the display will count down but not show the firmware revision.

Option Details Cont.



21: No Zero Suppression

Option 21 will disable the display's ability to suppress leading "0"s with spaces. The default (0) will display a space for all leading "0"s up to the final two in the 1s and 10s column or up to a "0" immediately in front of a decimal point. For example when the option is off the stream "000000" will become " 00" and the stream "0000.00" will become " 0.00". Setting this option to 1 will cause the display to show every "0" received.

22: No Auto Shift

Option 22 will cause the scoreboard to display the first 6 characters of the data stream when it is learned. When this option is off the scoreboard will attempt to shift the weight into view when learned.

23: Mirror

Option 23 enables a display to be read in a rear view mirror. The default (0) is for direct viewing.(1) is for mirror and all values greater than 1 will toggle back and forth between standard viewing and mirror viewing based on how often the indicator is transmitting data. The larger the value the more time between switching.

24: Fixed Decimal Point

Option 24 will set the display to illuminate a decimal point when it is not present in the data stream. Default (off) will show a decimal point only where it is located in the data stream. All other values represent the digit to attach a decimal point to, starting from right to left.

Value	Decimal Placement
0	Default
1	#####
2	#####.#
3	####.##
4	###.###
5	##.####
6	#.#####

Option Details Cont.



25: Fixed Annunciator

Option 25 will disregard the characters in the data stream and force the annunciators on according to the following chart.

Value	SSD Display
0	Use Data Stream
1	lb - GR
2	kg - GR
3	lb - NT
4	kg - NT
5	ALL OFF

26: Demo Mode

Option 26 is used to set the display to cycle through various weights for use as a demo unit without connecting to an indicator.

27: Counter

Option 27 turns the display into a counter. Set any value to "Count By" from 1 to 255. It requires the installation of a SG-SSD Card. The Red Input will trigger the display to increment by the "Count By" value. The Green Input will trigger the display to decrement by the "Count By" value. Value will not go below 0. The Amber Input will reset the counter. Using the Fixed Decimal Point option allows the remote to increment in fractions. Buttons are triggered on a low to high transition (IE when testing with a simple ground wire, the display will update when the wire disconnects).

28: Siemens

Option 28 enables the remote display to use a Siemens Milltronics BW500 Integrator and will direct the remote into a Siemens Sub Menu. Siemens Sub Menu Options may be downloaded at www.matko.com/siemens

Option Details Cont.



29: Blank Out Character 1

Option 29 sets a character in the data stream to look for to blank the display. For example if you want the display to blank when over capacity and the indicator sends an "O", set option 18 to 79.

30: Blank Out Character 2

Option 30 sets a character in the data stream to look for to blank the display. For example if you want the display to blank when over capacity and the indicator sends an "O", set option 18 to 79.

31: Blank Out Character 3

Option 31 sets a character in the data stream to look for to blank the display. For example if you want the display to blank when over capacity and the indicator sends an "O", set option 18 to 79.

32: Grams / Ounces

Annunciator will display according to the following chart when the designated character is in the data stream. Custom decals required. 'gr' replaces 'kg' and 'oz' replaces 'lb'.

Character	Display	Designator for
"G" or "g"	"G"	Gross Weight
"N" or "n"	"N"	Net Weight
"L" or "l"	"L"	Pounds
"K" or "k"	"kg"	Kilograms
"M" or "m"	"gr"	grams
"Z" or "z"	"oz"	Ounces

33: Future Option

Reserved for Future use.

34: Version

Option 34 displays the firmware revision of the display. The unit will display the month, followed by the year. This option is only used for trouble shooting purposes.

Section 6: Stoplight



Options 7, 8, and 9 select how the stoplight is controlled.

6.1 Individual Control

3 Line TTL Control Connect The Red/Green/Amber Terminal Blocks to either a switch toggling a Ground Loop, or to a 5 volt DC TTL device, referencing a common Ground.

Option 7 = RED Control

Option 8 = GREEN Control

Option 9 = AMBER Control

Circuit Logic:

Options 7-9 Set to 0 (*When Toledo Option is turned on, the Toledo Status Byte overrides the Terminal Block Inputs*)

Open/Pulled High = Color Off. Closed/Pulled Low = Color On

Options 7-9 Set to 1 (*When Toledo Option is turned on, the Terminal Block Inputs overrides the Toledo Status Byte*)

Open/Pulled High = Color Off, Closed/Pulled Low = Color On

Options 7-9 Set to 2 (*Inverted logic of Values 0/1*)

Open/Pulled High = Color On. Closed/Pulled Low = Color Off

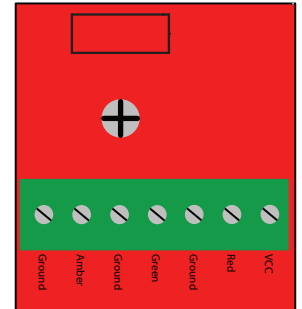

6.2 Single Switch Control

Switch/Single Line TTL (*Red and Green Only*)

Option 7 = 3

Connect a TTL Output or switch to the Red Terminal Block

Circuit Logic TTL:

Open/Pulled High = Red, Closed/Pulled Low = Green

6.3 Momentary Control

Momentary Green

Option 7 = 4

Option 8 = ###

Connect a switch between Ground and the Green Pin Terminal Block. When pin Green goes low the light will toggle from red to green and remain green for a certain number of data streams set with Option 8, then will go back to red.

Momentary Red

Option 7 = 5

Option 8 = ###

Connect a switch between Ground and the Red Pin Terminal Block. When pin Red goes low the light will toggle from green to red and remain red for a certain number of data streams set with Option 8, then will go back to green.

Stoplight Cont.



6.4 Minimum and Maximum Weight Control

Option 7 = 6

Lights are controlled based on the Minimum (Option 10) and Maximum (Option 11) Weight Options

When Weight is under the Minimum Weight, Light is GREEN

When Weight is between the Minimum and Maximum Weights, Light is AMBER

When Weight is over the Maximum Weight, Light is RED

6.5 ASCII Control

Option 7 = Any ASCII character from 07(BEL) to 127(DEL) for the Red light.

Option 8 = Any ASCII character from 07(BEL) to 127(DEL) for the Green light.

Option 9 = Any ASCII character from 07(BEL) to 127(DEL) for the Amber light.

Result

When the character set in option 7 is in the data stream the Red light will be on.

If the character is not in the data stream then the Red light will be off.

When the character set in option 8 is in the data stream the Green light will be on.

If the character is not in the data stream then the Green light will be off.

When the character set in option 9 is in the data stream the Amber light will be on.

If the character is not in the data stream then the Amber light will be off.

6.6 One Time ASCII Control

Option 7 = 0

Option 8 = 4

The Serial Traffic commands can be used to set the traffic lights with one time commands. Unlike the standard ASCII Control which controls the traffic lights via a character constantly within the stream, this option will set the traffic light based on the command code sent once and then that state will hold until a new command is sent. The command character must be within a set data stream format. If Option 1 is set then the command code must be after the addressable character and must be before the end character set as option 15. The command may be sent as a part of a larger stream including weight or in a simple two character stream of command character followed by the end character. The four command characters are:

DC1 (Decimal 17) = Turn Red Light On

DC2 (Decimal 18) = Turn Green Light On

DC3 (Decimal 19) = All Lights Off

DC4 (Decimal 20) = Turn Amber Light On

Stoplight Cont.



Axle System Programming

There are three types of programs to select from to control traffic to receive axle weights and totals.

- A simple Axle Scale
- An Inbound Truck Scale (driving on)
- An Outbound Truck Scale (driving off)

The general rule for all systems is a green light means the remote is ready to accept the next axle.

A red light means to come to a stop when the next axle is in position.

6.7 Axle Scale Control - Use with axle scale

Set Option 7 = 0

Set Option 8 = 6

Sequence of Operations

- Scale is at zero with a green light.
- Truck pulls on first axle. The light will turn red signaling to stop when the axle is in position. Once stable it will display "A-1" for axle 1 then will show the weight.
- The light will turn green to signal ready for next axle.
- Truck will pull on each additional axle on the scale one at a time. The light will turn red to signal stop when axle is in position, display "A-N" for the axle number then the weight.
- After the last axle is weighed and the truck pulls off the display will show "total" then the total weight of all axles.
- The system will then reset for the next truck with a green light.

6.8 Inbound/Outbound Scale Control - Use with a full truck scale

Inbound Truck Scale Program

Set Option 7 = 0

Set Option 8 = 7

Sequence of Operations

- Scale is at zero with a green light.
- Truck pulls on first axle. The light will turn red signaling to stop when the axle is in position. Once stable it will display "A-1" for axle 1 then will show the weight.
- The light will turn green to signal ready for next axle.
- Truck will pull on each additional axle on the scale one at a time. The light will turn red to signal stop when axle is in position, display "A-N" for the axle number then the weight.
- After the last axle is weighed and the truck remains on the scale. The display will show "total" then

the total weight of all axles.

- The system will then reset for the next truck with a green light.

Outbound Truck Scale Program

Set Option 7 = 0

Set Option 8 = 8

Sequence of Operations

- **Scale is at zero with a green light.**
- Truck pulls all the way onto the scale. The light will go red signaling stop when in position. After the scale is stable it will display "total" then display the total weight.
- The light will turn green to signal ready to remove the next axle.
- Truck pulls off first axle. The light will turn red signaling to stop when the axle is in position. Once stable it will display "A-1" for axle 1 then will show the weight.
- Truck will pull off each additional axle on the scale one at a time. The light will turn red to signal stop when axle is in position, display "A-N" for the axle number then the weight.
- After the truck pulls off the scale and the last axle is displayed the system will reset and the light will turn green.

Section 7: Wireless



Wiring Diagram

For a typical scale applications, Connect one XTP Module as the transmitter (using **BLACK** Terminal Block) to the indicator and the second unit as the receiver (using the **GREEN** Terminal Block) to the Remote Display, or use a built in XTP Receiver.

XTP as Transmitter (Indicator side) (Black Terminal Block)

	Indicator	Pin	Display	Connector Pin Out														
Indicators with Active 20 mA Output	+20mA	5	RX CL (+)	<div style="border: 1px solid black; padding: 5px; display: inline-block;"> <table style="width: 100%; border-collapse: collapse;"> <tr><td style="text-align: center;">1</td><td>+9 VDC</td></tr> <tr><td style="text-align: center;">2</td><td>GROUND</td></tr> <tr><td style="text-align: center;">3</td><td>232 RXD</td></tr> <tr><td style="text-align: center;">4</td><td>RX CL(-)</td></tr> <tr><td style="text-align: center;">5</td><td>RX CL(+)</td></tr> <tr><td style="text-align: center;">6</td><td>RX 422A</td></tr> <tr><td style="text-align: center;">7</td><td>RX 422B</td></tr> </table> </div>	1	+9 VDC	2	GROUND	3	232 RXD	4	RX CL(-)	5	RX CL(+)	6	RX 422A	7	RX 422B
	1	+9 VDC																
2	GROUND																	
3	232 RXD																	
4	RX CL(-)																	
5	RX CL(+)																	
6	RX 422A																	
7	RX 422B																	
-20mA	4	RX CL (-)																
Indicators with Passive 20 mA Output	+20mA	1	+9 VDC															
		2	GROUND															
		4	RX CL(-)															
	-20mA	5	RX CL(+)	} JUMP														
Indicators with RS232 Output	TXD	3	232 RXD															
	GND	2	GND															
Indicators with RS422 Output	TX 422A (+)	6	RX 422A															
	TX 422B (-)	7	RX 422B															

Figure 8.1: Wiring Diagram

The corresponding **green** LED will blink with every data transmission regardless of any wireless network being present or configuration settings.

XTP as Receiver (Remote Display side) (**GREEN** Terminal Block)

All 3 loops (RS232, RS422, and Current Loop) transmit with every data wireless signal received.

Wireless Cont.



Configuration

All units must be on the same ID to communicate with each other. There are 16 IDs available (IDs 0 through 15)

For each Radio in the system:

1. Set the **BLACK ID DIP** switch to the desired ID
2. Set the **BLUE BAUD RATE DIP** switch to match the serial device connected to the XTP unit.
*Any change in DIP Switch settings will cause the **RED CONFIG LED** to turn on. Transmission will be disabled until step 3 is performed. The **BLACK DIP** for TEST MODE must be off for normal operation.
3. Press the **CONFIG** button. The three **GREEN** configuration LEDs will illuminate as setup progresses.
When all three LEDs light up Configuration is complete. **

If there is a problem with configuration the **RED CONFIG LED** will blink every 5 seconds up to 6 times. **RED CONFIG LED** will then blink several times rapidly. Wait a minimum of 5 seconds before pressing the **CONFIG** button again.

** It may take up to 30 seconds after configuration before a link is established with other units and data is transmitted between units.

When the XTP has been properly configured and properly wired according to Section 1 the corresponding **GREEN LED** (RS232, CLOOP, or RS422) will blink with each data transmission. The **RED Receiving Wireless Signal** LED will blink with each data burst received from the matching transmitter. Ideally with each **GREEN** blink on the transmit side there will be a corresponding **RED** blink on the receiver side. If the receiver side is infrequent the signal is not reliably getting from one unit to the other. Reposition antennas for direct line of sight as much as is feasible.

Optional IO (Input Output) Cards

The XTP Module has the option to add up to 2 cards used for IO line passing for other XTP units on the same ID. Each card has either 4 input or 4 outputs. Each system can only have one **WHITE** input card on IO Card 1 and 1 **WHITE** input card on IO Card 2. These units may be in the same XTP unit or different units. Any system can have as many **BLACK** Output cards as required on any IO Card slot without interference

Changing IO cards may require repeating step 3 above as indicated if the **RED CONFIG LED** turns on.

IO Card 1 controls IO 1 through 4 and IO Card 2 controls IO 5-8 (Card is labeled 1-4 and can be swapped into either slot.

Only IOs 0-7 are sent using IDs 0-5 and 12-15 (to maintain backwards compatibility with older XT Series models.

If 8 IOs are required use IDs 6-11

The XTP Built in Receiver has IO 1-3 tied into the stoplight controls on SSD series displays.

IO 1 controls the red line

IO 2 controls the green line

IO 3 controls the amber line

Wireless Cont.



Board Layout

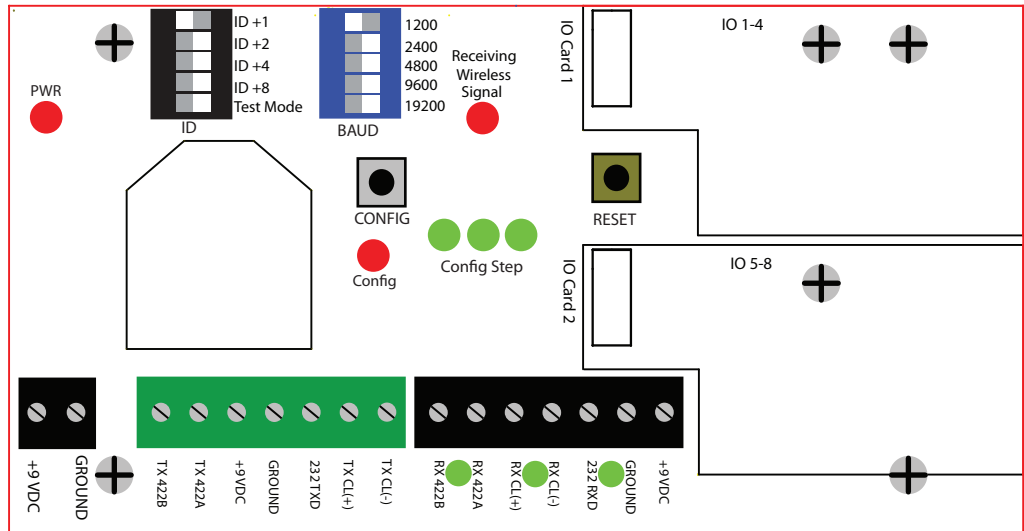

Figure 7.2: XTP Module

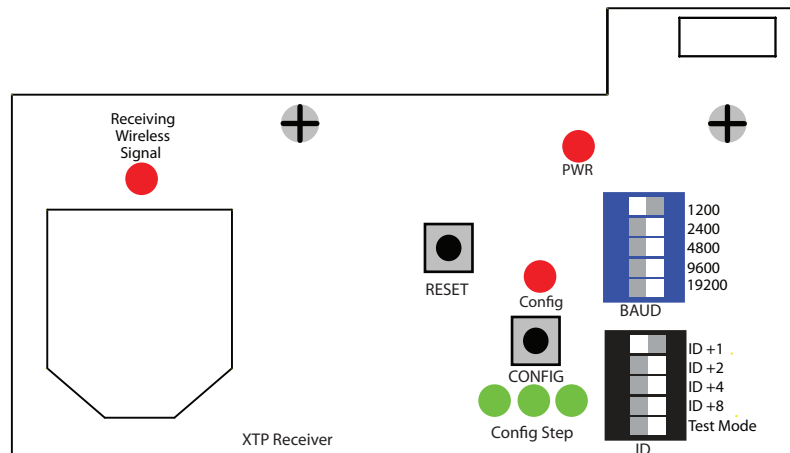

Figure 7.3: XTP Built in Receiver

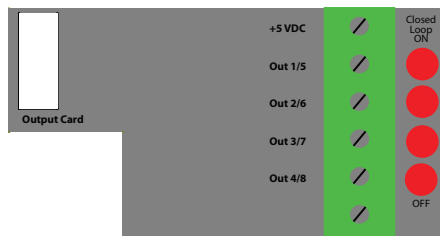

Figure 7.4: XTP Output Card

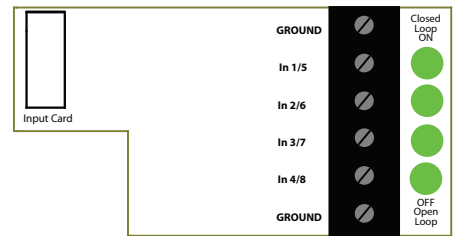

Figure 7.5: XTP Input Card

Wireless Cont.



Product Comparison

	XT100 Legacy	XT300 Legacy	XT400 Legacy	XTP
Line of Sight Distance	Up to 1 mile	Up to 1 mile	Up to 1 mile	Up to 2 Miles
Baud Rate	9600 (Fixed)			
1200		▲	▲	▲
2400		▲	▲	▲
4800		▲	▲	▲
9600		▲	▲	▲
19200		▲	▲	▲
Protocol				
RS232	▲	▲	▲	▲
20 mA Current Loop		▲	▲	▲
RS422 /485		▲	▲	▲
Approvals				
US (FCC)	▲	▲	▲	▲
Canada (IC)		▲	▲	▲
Europe (ETSI)		▲	▲	▲
Network ID's	1	16	16	16
TTL Line Passing	0	0	Up to 4	Up to 8
Configuration	Fixed	In Field	In Field	In Field
Enclosure	NEMA 4 IP65	NEMA 4 IP65	NEMA 4 IP65	NEMA 4 IP65

Figure 7.6: Comparison Chart

Compatibility:

The XTP Module is compatible with the prior versions XT100/XT200/XT300/XT400 so long as they are on the same ID with the exception that ID #s 6-11 will not communicate. IDs 0-5 and 12-15 are compatible and should be used whenever intermixing modules.

RF Exposure

WARNING: To satisfy FCC RF exposure requirements for mobile transmitting devices, a separation distance of 20 cm or more should be maintained between the antenna of this device and persons during device operation. To ensure compliance, operations at closer than this distance is not recommended. The antenna used for this transmitter must not be co-located in conjunction with any other antenna or transmitter. The preceding statement must be included as a CAUTION statement in OEM product manuals in order to alert users of FCC RF Exposure compliance.

Section 8: Troubleshooting



General Purpose Solution:

Set the transmitting device to 1200 BAUD; 8 data bits; no parity. Make sure the data stream contains 6 weight characters followed by a carriage return, line feed or end of text. **Set the display to factory default and re-learn the display.**

The red LED is on and the display reads "NoData".

Communication was lost.

Suggestions:

Make sure the indicator is powered on.

Make sure the indicator port is enabled to transmit data continuously.

Make sure the wiring is correct. (The corresponding green LED should blink with every data transmission).

If data delay between data streams is greater than 2 seconds, turn on option 4.

The unit displays ERROR[X].

Suggestions:

Verify data stream is set to 1200-9600 baud, 8 data bits, no parity with a carriage return [CR], line feed [LF], or end of text [ETX] at the end of the data stream. If the unit is wired for RS485, try reversing the wires.

The unit displays the incorrect digits.

Suggestions:

Try shifting the data to the right or left.

Lower the BAUD rate, default the unit, and re-learn

Rice Lake indicators:

Suggestions:

Set End of Line Delay (EOL Delay) to 250 ms or higher.

Do not set to 0 ms.

Display updates slowly.

Suggestions:

Increase the frequency of data transmission.

Turn on option 4.

Default Remote display and re-learn

Section 9: ASCII Table



Dec	Char		Dec	Char		Dec	Char		Dec	Char
0	NUL	null	32	Space		64	@		96	`
1	SOH	start of heading - 0x01	33	!		65	A		97	a
2	STX	start of text - 0x02	34	"		66	B		98	b
3	ETX	end of text - 0x03	35	#		67	C		99	c
4	EOT	end of transmission	36	\$		68	D		100	d
5	ENQ	enquiry	37	%		69	E		101	e
6	ACK	acknowledge	38	&		70	F		102	f
7	BEL	bell	39	'		71	G		103	g
8	BS	backspace	40	(72	H		104	h
9	TAB	horizontal tab	41)		73	I		105	i
10	LF	line feed - 0x0A	42	*		74	J		106	j
11	VT	vertical tab	43	+		75	K		107	k
12	FF	form feed, new page	44	,		76	L		108	l
13	CR	carriage return - 0x0D	45	-		77	M		109	m
14	SO	shift out	46	.		78	N		110	n
15	SI	shift in	47	/		79	O		111	o
16	DLE	data link escape	48	0		80	P		112	p
17	DC1	device control 1	49	1		81	Q		113	q
18	DC2	device control 2	50	2		82	R		114	r
19	DC3	device control 3	51	3		83	S		115	s
20	DC4	device control 4	52	4		84	T		116	t
21	NAK	negative acknowledge	53	5		85	U		117	u
22	SYN	synchronous idle	54	6		86	V		118	v
23	ETB	end of trans. block	55	7		87	W		119	w
24	CAN	cancel	56	8		88	X		120	x
25	EM	end of medium	57	9		89	Y		121	y
26	SUB	substitute	58	:		90	Z		122	z
27	ESC	escape	59	;		91	[123	{
28	FS	file separator	60	<		92	\		124	
29	GS	group separator	61	=		93]		125	}
30	RS	record separator	62	>		94	^		126	~
31	US	unit separator	63	?		95	_		127	DEL

Section 10: Replacement Parts



Part Number	Description
INPUT-CARD-SSD	Serial Data Input Card
L2-SSD	SSD-2 LED Board
LED-KIT-SSD5	Kit with all 6 Digits for SSD-5 Displays
L5-SSD-L	SSD-5 Left LED digit Board (100,000s and 10,000s digits)
L5-SSD-C	SSD-5 Center LED digit Board (1,000s and 100s digits)
L5-SSD-R	SSD-5 Right LED digit Board (10s and 1s digits)
LED-KIT-SSD8	Kit with all 6 Digits for SSD-8 Displays
L8-SSD-L	SSD-8 Left LED digit Board (100,000s and 10,000s digits)
L8-SSD-C	SSD-8 Center LED digit Board (1,000s and 100s digits)
L8-SSD-R	SSD-8 Right LED digit Board (10s and 1s digits)
AN-SSD	SSD-5/SSD-8 Annunciator Dot Board
LBKG-SSD	SSD-5-A/SSD-8-A "LB KG G N" Annunciator board
SGB-SSD	SSD-5SG/SSD-8G TRI Stoplight and annunciator board
SG-CARD-SSD	SSD-5SG/SSD-8SG Input stoplight card
PWR-SSD-AC	SSD 100-240 AC Power Supply with holding tray
PWR-SSD-DC	SSD 12-35 DC Power Supply with standoffs
PWR-TRISG8-AC	SSD-8-TRISG 24 volt power supply on SG Side
RC-SSD-14	Ribbon cable for SSD5 and SSD8 Displays
Cable-SSD-PWR	AC and DC Wiring Harnesses for SSD5 and SSD8 including AC power cable and strain relief
XTP-BIR	XTP Built in Receiver Card
Wireless-XB3-ANT-9dBi	9dBi Omni Directional Antenna with wall mounting bracket
Wireless-XB3-ANT-Yagi	18 dBi Directional Antenna

Section 11

Manual Revision History



Revision	Descriptions
1.2	Updated Chart 1.1: Display Sizes
1.1	Added Option 27 (Counter Option) and minor fixes
1.0	Initial SSD Manual Release

Do a favor for the next tech that works on this remote (It might be you!)

Make note of any special settings or issues you encountered to get this system working properly and keep this page inside the remote display

Display Notes:

RS232 / Current Loop / RS422

_____Baud _____Databits _____Parity

Options turned on

Indicator Notes:

Problems encountered, Wiring Notes, Special hardware needed...